



Product Specification

Name : **ONN-LED Freezer Light**

Model : **ONN-X5D**

Date : **2015-03-18**

Version : **A 0**

Product Features:

1. Unique patent design, more functional.
2. Adjustable for lighting direction.
3. Great energy-saving, long life span, environmentally friendly.
4. SMD2835 LED light source, high brightness, low power cost, stable performance, low light decay.
5. Good heat dissipation aluminum house, easy for installation.
6. Application: refrigerator, jewellery showcase, cabinet and so on.

Pictures:

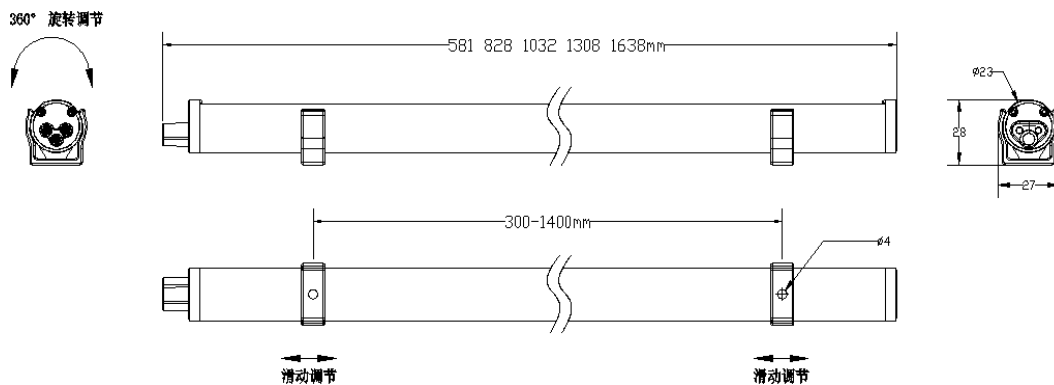

Basic Data:

Model	Nominal Voltage	Voltage Rang			CCT
□ONN-X5D-C1	AC220V (50/60Hz)	AC100-240V (50/60Hz)			5500-6000K
□ONN-X5D-C2	AC220V (50/60Hz)	AC100-240V (50/60Hz)			4000-4500K
□ONN-X5D-C3	AC220V (50/60Hz)	AC100-240V (50/60Hz)			2800-3200K
Wire Length:	Around 0.15M(standard)				□
Installation:	□ fix with clip				
Lamp Length:	□600mm	□ 900mm	□ 1200mm	□ 1500mm	□ 1800mm
Power Cost:	6.5W	9.5W	13.5W	16W	18W
Input Current:	(220V) 29mA	(220V) 43mA	(220V) 68mA	(220V) 77mA	(220V) 80mA
Luminous Flux:	720 Lm	1000 Lm	1100 Lm	1650 Lm	1900 Lm
Protection:	IP53	CCT:	5500—6000K /2800-3200K 4000-4500K		
Efficiency:	100-110Lm/W	CRI:	Ra80		
LED Driver:	Non-isolated	PF:	≧0.5		
Surface temperature:	-20 to 60℃	Beam Angle:	120°		
Life:	50 000H				

Working Conditions:

Ambient Temperature:	-20~45℃
Storage Temperature:	-40~70℃
Ambient Humidity:	10~90%
Storage Humidity:	10~90%

Light Distribution Curve:

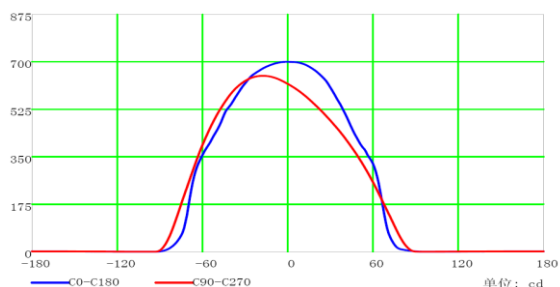
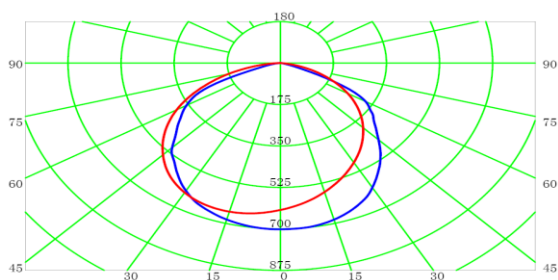

Average Illumination:

灯具有效平均照度图

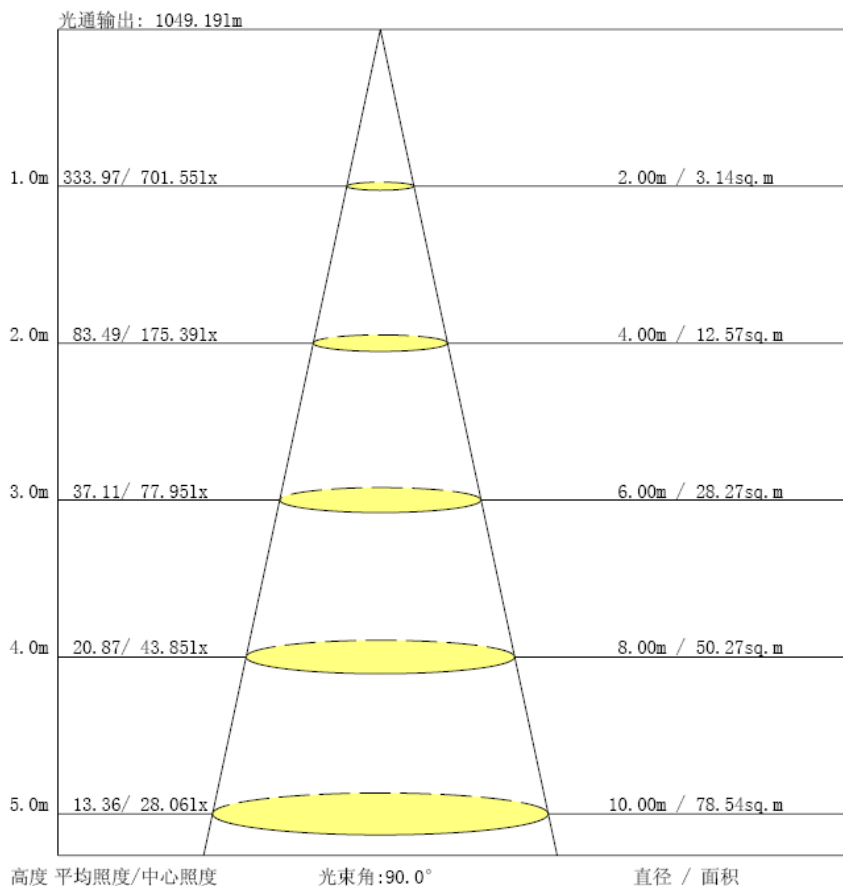

Packing:

Package Material	carton			
Lamp Length (MM)	600	900	1200	1500
Lamp Weight (Kg)	0.16	0.21	0.29	0.33
Weight/CTN (Kg)	9	11.8	15.5	18
PCS/CTN	49	49	49	49
Carton Size (L*W*H)mm	660*210*200	960*210*200	1260*210*200	1560*210*200

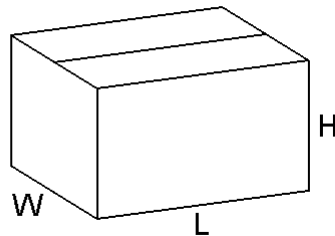
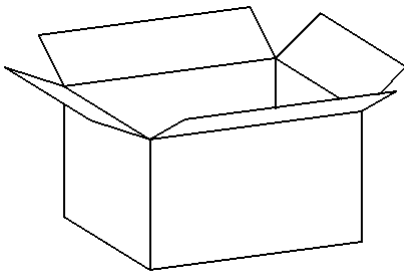

Installation:

1. Fix the clips with screws. (screw outer diameter $\Phi 3.5\text{mm}$)
2. Fix the lamp into the clips.
3. Connect the connector to the lamp. Lamp can be connected one to one. Please note suitable connection length.
4. Rotation adjustable for lighting direction.

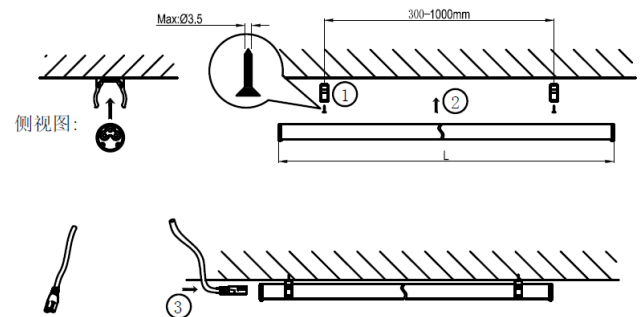

Warranty:

1. 18 months free warranty for quality failure.
2. If following facts, warranty will be limited:
 - (1) Date Changed.
 - (2) User's improper use or damage.
 - (3) Outlook damage or shortage for lamp or package is not within warranty.

- (4) Failure caused by improper use or setting.
- (5) Open or maintenance not by us or our agents, or without our permit.
- (6) Failure caused by act of god.
- (7) Other causes not due to quality problems.

3、 If exceeds warranty time, it will be not free any more for warranty.