

## Product specification

Name : ONN-LED Flat machine light

Model : ONN-M9T (Integrated)

Version : A0

Date : 2017-01-03

**Products introduce:**

1. ONN-M9T series of products using die-cast structure, waterproof tape, waterproof silicone, glass and other components combine;
2. lighting the overall thermal performance, simple and elegant appearance, exquisite beauty;
3. protection class IP65, resistant to water, high temperature, coolants and lubricants, 28mm thickness, save space.
4. Adapt 3030 Taiwan imported lamp beads, small size, low thermal resistance, good thermal conductivity, low light is the best choice for lighting;
5. Using the anchor screws, the beam angle can be adjusted by the base.

**Application:** Interior lighting of various machine tool, like engraving machine, EDM, machining center, cnc machine, grinding machine, where need a local lighting.

**Product photo and size drawing:**

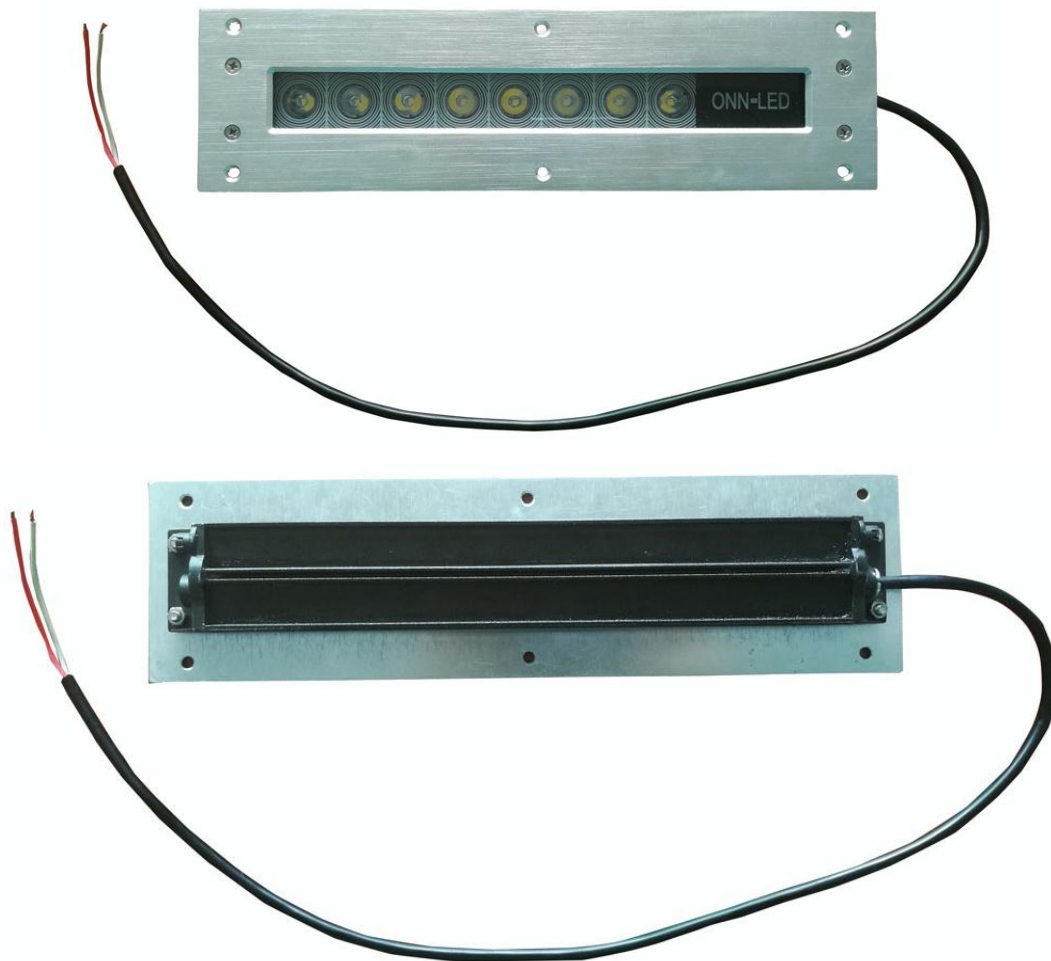

---

**Shenzhen Onn Semi-conductor lighting Co.,Ltd**

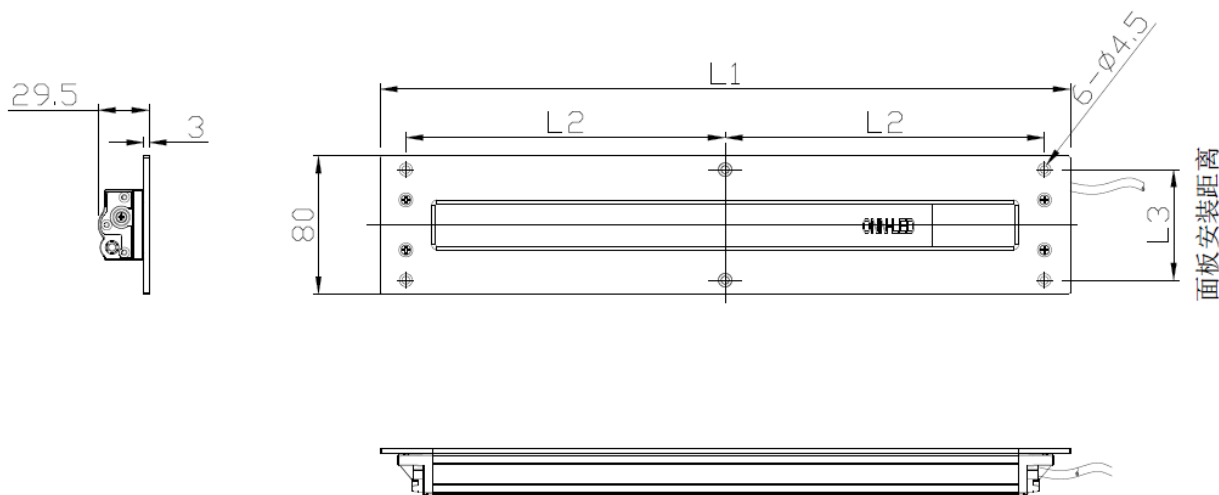

Unit: mm

Specification	300S	400S	500S	600S
L1	300	400	500	600
L2	135	185	235	285
L3	64			
Hole size	285*45	385*45	485*45	585*45

Marks: Need 6pcs M4\*0.7 Screws to fix the lamp, drill M4 screw hole accordingly.

### Technical parameter:

Model	Input standard voltage	Input voltage range	CCT	
□ONN-M9T-B1	DC 24V	DC 24±2V	5500-6000K	
□ONN-M9T-B2	DC 24V	DC 24±2V	4000-4500K	
Power wire length	■ About 0.6M(Standard) no plug fitted			
Lamp length	□300 mm	□400 mm	□500 mm	□600 mm
Power dissipation	8W	12 W	16 W	20 W
Input current	320mA	500mA	680mA	840mA
Light flux	635Lm	1000 Lm	1330 Lm	1500 Lm
IP class	IP65	CCT Range	5500 – 6000K	4000-4500K
Light efficiency	70-75Lm/W	CRI(>Ra)	≧ 80	

### Shenzhen Onn Semi-conductor lighting Co.,Ltd

Tel: +86-755-36631969 Fax: +86-755-27871421 Web: [www.onnled.net](http://www.onnled.net)  
 Add: F, Haofeng Industrial Park NO.2 Zone, Xinhe, Bao'an District, Shenzhen, China.

Power supply	Low voltage non-isolated	Beam angle	60°
Work temperature	< 60°C	Installation type	Fixed by screws
Lifetime	50 000H		

**Environmental Requirements:**

<b>Working temperature:</b>	-20~45°C
<b>Save temperature:</b>	-40~70°C
<b>Working humidity:</b>	10~90%
<b>Save humidity:</b>	10~90%

**Luminous Intensity Distribution Diagram:**

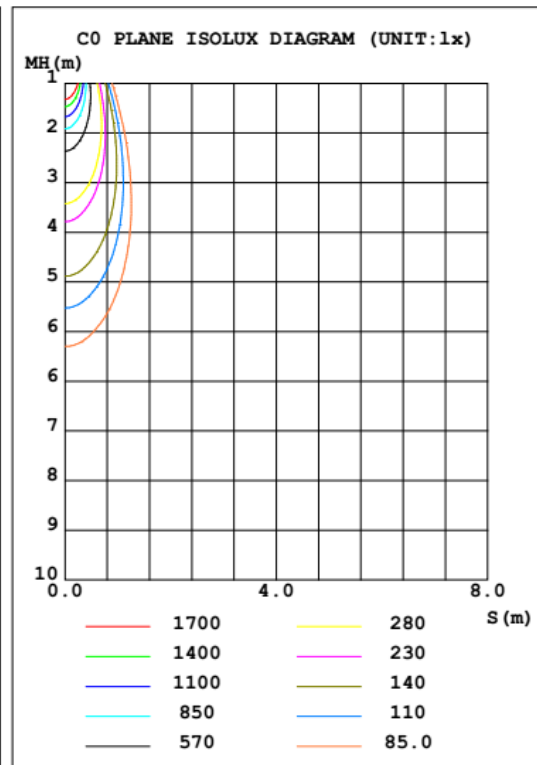
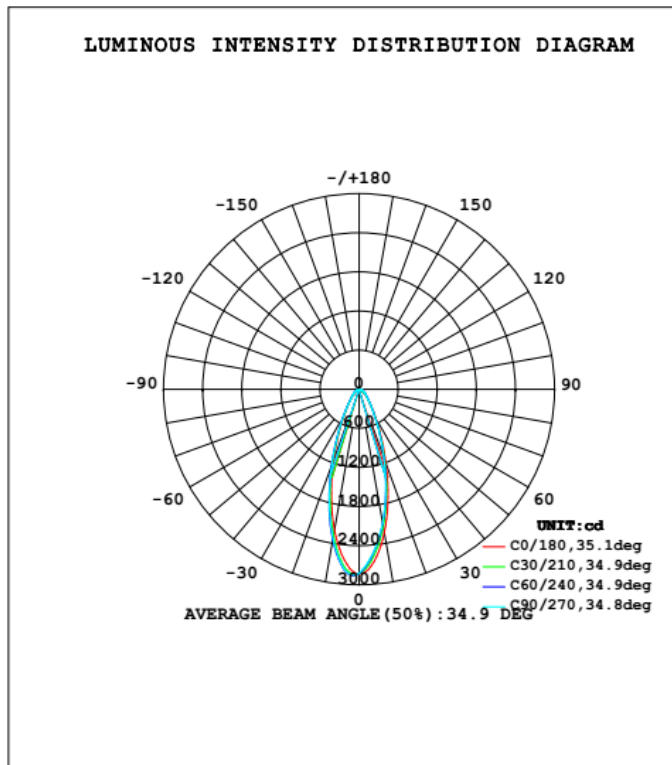



## Effective Average Illuminance Diagram

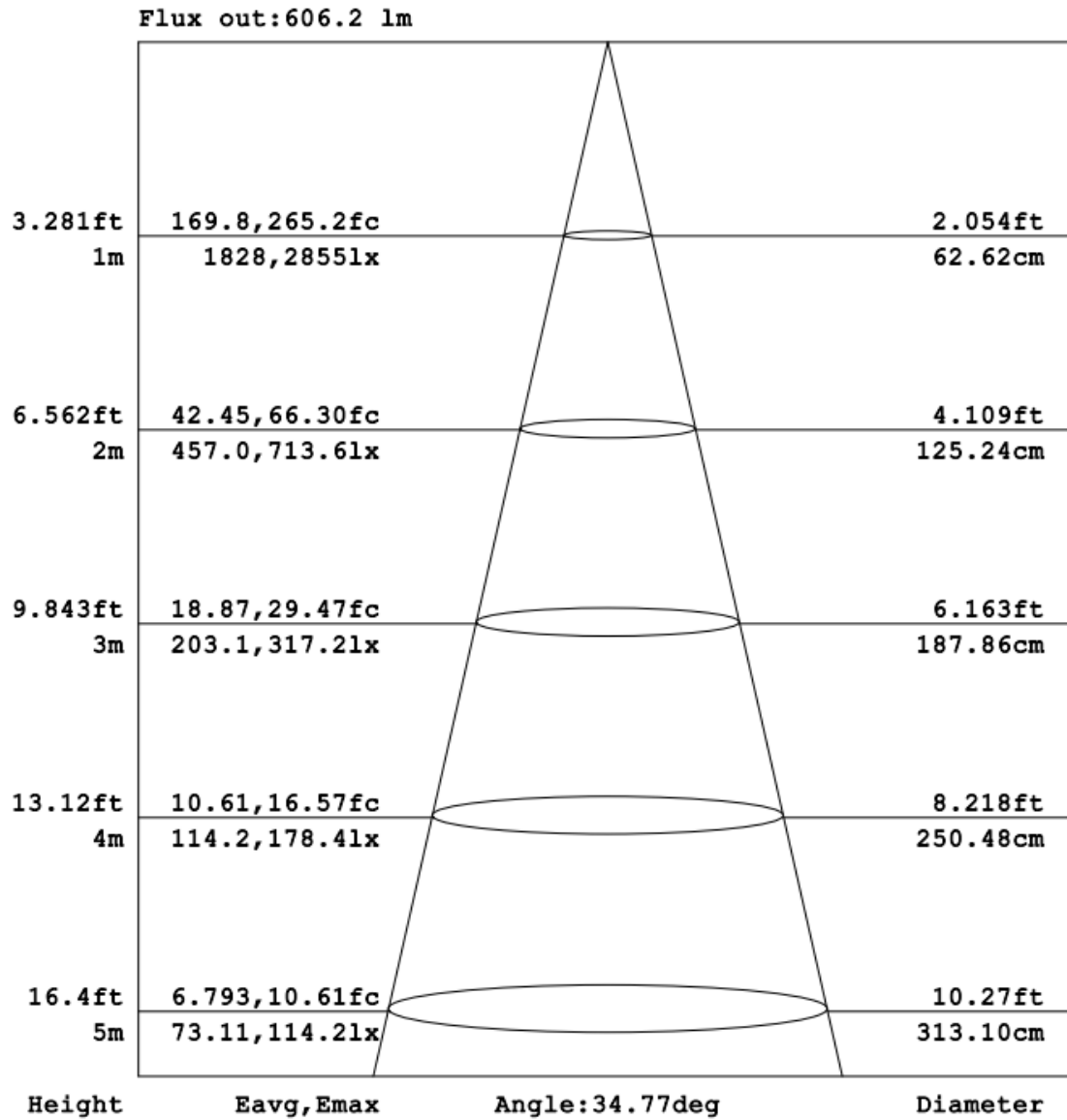

(M9T-B1-280)

**Packing:**

Packing material	Carton			
	300	400	500	600
Size of products (MM)	300	400	500	600
N/W of one light (Kg)	0.48	0.6	0.75	0.9
G/W of total cartons (Kg)	12	13.4	12.3	14
Quantity/CTN (PCS)	24	18	12	12
Carton size(L*W*H)mm	780*340*233	980*260*233	780*370*233	780*340*233
Inner box(L*W*H)mm	770*80*70	970*80*70	770*80*70	770*80*70

**Installation:**

- 1) Drill M4 screw hole in the specified place, screw hole distance is showed below for your reference.
- 2) Use 6pcs M4\*0.7 Screws to fix the lamp.

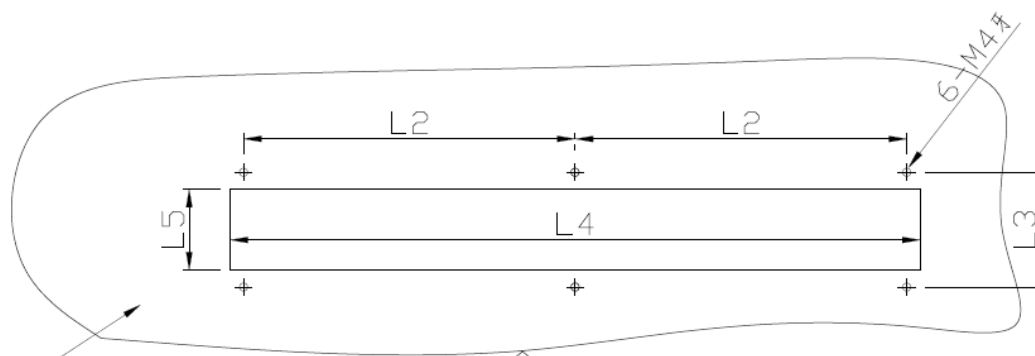

Installation place on machine tool with M4 screw holes drilled in advance



Put lamp in



**24V cable**

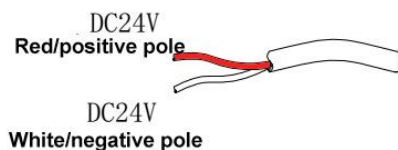

Unit: mm

Specification	300S	400S	500S	600S
L2(Screw hole horizontal distance)	135	185	235	285
L3(Screw hole vertical distance)	64			
Hole size	285*45	385*45	485*45	585*45

---

**Shenzhen Onn Semi-conductor lighting Co.,Ltd**

Tel: +86-755-36631969 Fax: +86-755-27871421 Web: www.onnled.net  
Add: F, Haofeng Industrial Park NO.2 Zone, Xinhe, Bao'an District, Shenzhen, China.