

Product specification

Name : ONN-LED machine work light

Model : ONN-M4S series

Version : A0

Date : 2015-01-28

一、Products introduce:

- 1、Delicate structure, simple and beautiful, competitive price;
- 2、The radiating of light is good, to insure the life spans of products;
- 3、China famous power.

二、Products photo, link style photo, size photo :

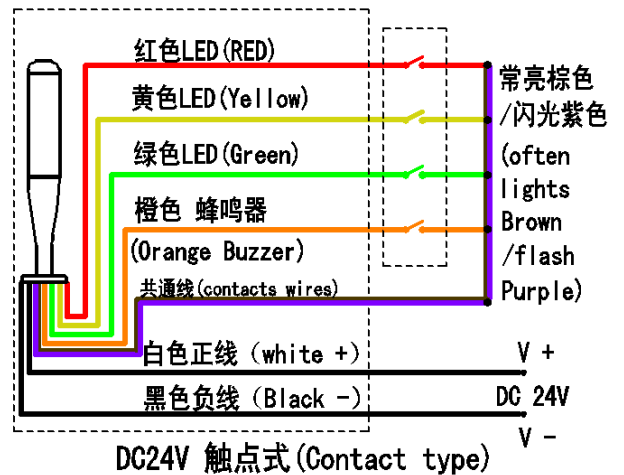
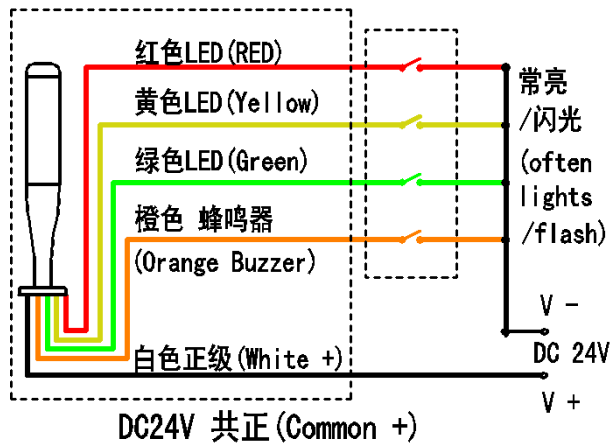
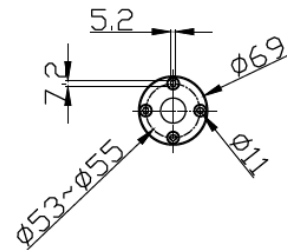
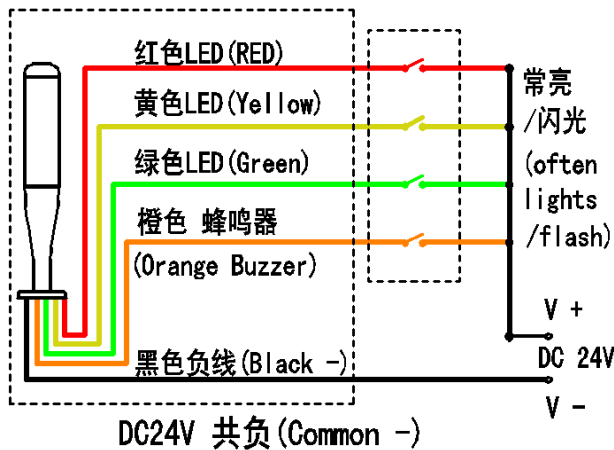
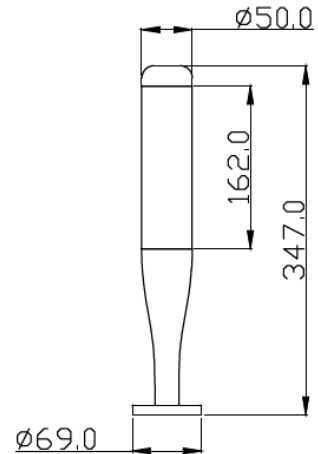



三、Product Code Principles:

ONN -M4S A - 3 B B B	
① ② ③ ④ ⑤ ⑥ ⑦	
①	Name: ONN 欧恩
②	Three-color light color stick series: M4S
③	Shape: A, Baseball bat type B, Cylindrical
④	Color quantity: 3 colors
⑤	Voltage: B, 24V
⑥	Link style: C, contact style (with a common line) Z, Positive electrode link B, negative electrode link
⑦	B, Normal light F, Normal light with buzzer S, Red fashion C, Red fashion with buzzer D, All fashion E, All fashion with buzzer

四、Parameters

Model No.:		M4S			
Input voltage	DC24V	Input Current	60~200mA	Power	Single color: 1.2~2.4 W Total power: 5W
IP rating	IP50	Length	<input type="checkbox"/> 0.5M <input type="checkbox"/> _____		
Special request:					
Brand	ONN, Shenzhen ONN Semi-conductor				
Light	Chips 3528 LED 0.06W/pcs				
Life spans	Life spans of light is 100000 hrs; the whole light life: 50000 hrs				
Beam angle	Single light 120 degree, The whole light 360 度可视				
Original place	Shenzhen China				

五、Products shape

Shape design	Baseball bat type, Smooth curve over, Advanced plating.
Color of light body	silver
Material	PC (Bulletproof plastic) 、ABS Engineering Plastics

六、Environmental Requirements:

Working temperature:	-20~45℃
Save temperature:	-40~70℃
Working humidity:	10~90%
Save humidity:	10~90%

七、Packing:

Packing material	cartons
N/W of one light (Kg)	0.5
G/W of total cartons (Kg)	8.2
Qty in carton (PCS)	12
Size of inner box (L*W*H) mm	415*80*80mm
Size of outer carton (L*W*H) mm	440*265*345mm

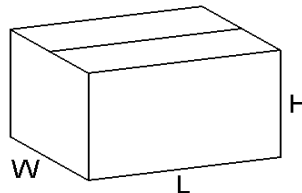
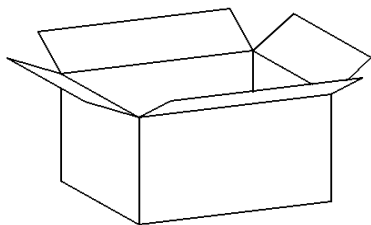

八、Repair list:

- 1、The warranty of the products is 18 months. If broken in natural within the warranty, please bring invoice and date in the light to repair free.
- 2、The following cases are not covered by the warranty, service charges paid by:
 - (1) Altered fixture dates
 - (2) The broken is because of improper use by user;
 - (3) The body of light and bundled products is broken or lost can't warranty;
 - (4) The broken reason is not natural, such broken by wrong input voltage and set up to lead to light can't work;
 - (5) Dismantle and repair have not agree with factory, repair and alter by the other repair person not in authorized service station;
 - (6) The broken is caused by fires, earthquakes, floods, lightning or other

natural disasters, pollution and abnormal voltage.

(7) Lights need to repair because rodents, salt spray, corrosion.

3、Exceed warranty period, repair will be charge fees as standard. Service charge = repair fees + material fees + freight fees.