

LED Long Arm Work Light ONN-M2

Introduction:

1. Anodized aluminum and tempered glass, resistant to corrosion and high temperature.
2. IP65 waterproof, suitable for variety of environment.
3. High efficiency LED chip with PC lens, high lumen output and lighting evenness.
4. Arms with flexible joints, convenient to position lamp and control lighting direction.
5. Variety of input voltages optional to fit different applications, AC100-240V 50/60Hz, AC/DC12V, AC/DC24V.

Application:

CNC machine work: engraving machine, EDM machine etc.
 Assembly and repair work.
 Laboratories.

Warranty: 2 years

Certification: CE, RoHS, FCC



Ordering code:

ONN M2 - B 1 9.5W S

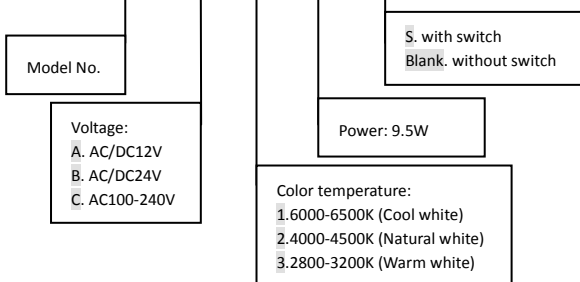

Dimension(mm):

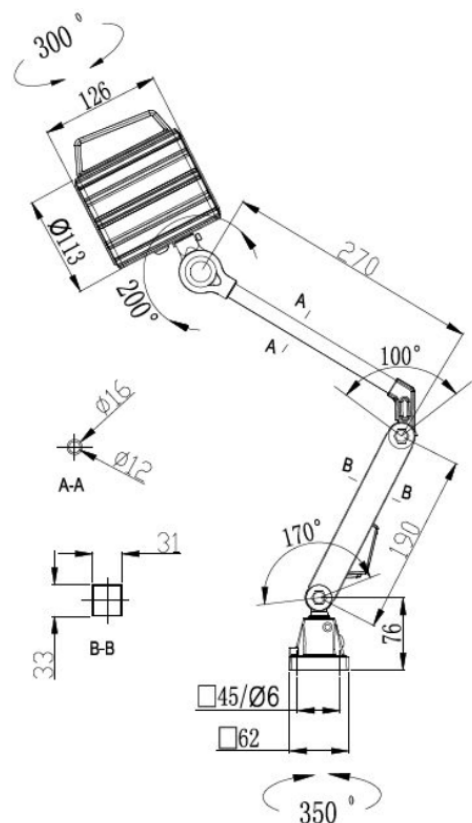

Parameter:

Power	9.5W
Input voltage	AC100-240V(50-60Hz), AC/DC24V, AC/DC12V
Lumen output(Efficiency)	830lm (87lm/w)
CRI	>80
IP rating	IP65
Beam angle	33 deg
Color temperature	2800-3200K, 4000-4500K, 6000-6500K
Material	Aluminum housing , PC lens, PA+15%GF base
Lifetime	50,000 hours
Working temperature/ humidity	-20~45℃ / 10%-90%
Storage temperature/ humidity	-20~60℃ / 10%-90%
Arm length(A+B)	27cm+19cm(standard), 24cm+32cm, 29cm+40cm, 37cm+40cm, 37cm+48cm
Installation	Fixed by screws

* If you need customized arm length, please check it with our sales.

Light distribution data

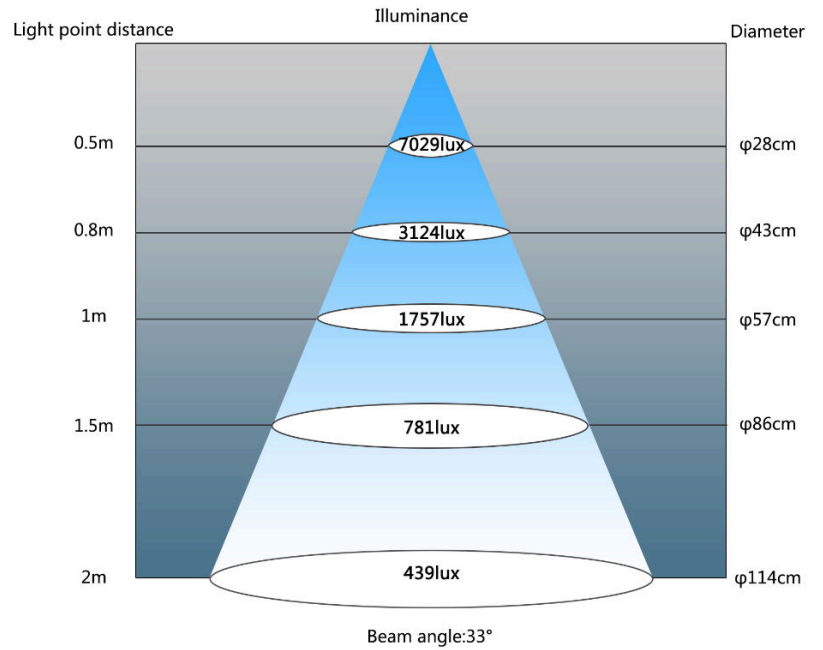
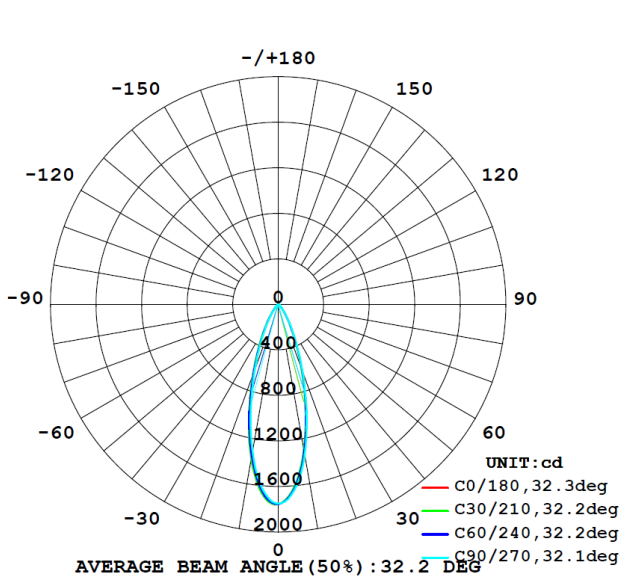

Wire connection:

DC12/24V Cable

Positive(+): Red

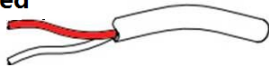

Negative(-): White

AC100-240V Cable

L : Brown



N : Blue

Package info (M2 with standard arm length)

Qty/carton	12pcs/carton
Carton Size	L620*W380*H460mm
Net Weight	16.8kg
Gross Weight	19.3kg

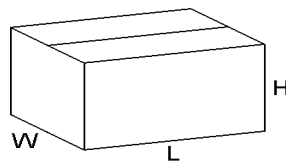
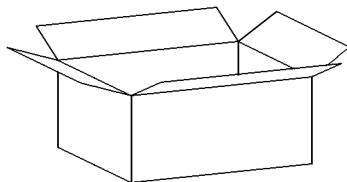

Shenzhen Onn Semi-conductor lighting Co.,Ltd

Tel: +86-755-36631969 Fax: +86-755-27871421 Web: www.onnled.net

Add: Haofeng Industrial Park NO.2 Zone, Xinhe, Bao'an District, Shenzhen, China.